

## **CASE NO. 146-S-24**

*PRELIMINARY MEMORANDUM*

*July 17, 2024*

Petitioner: **Steven Hillard**

Request: **Authorize a Special Use Permit for the use of an existing artificial lake of 1 or more acres in area in the CR Conservation-Recreation Zoning District, per Section 5.2 of the Champaign County Zoning Ordinance.**

Subject Property: A 20.44-acre tract in the Northwest quarter of Section 26, Township 21 North, Range 7 East of the Third Principal Meridian, in Newcomb Township, also known as tract 4B on a Plat of Survey recorded as Document No. 2022R10868 recorded with the Champaign County Recorder of Deeds, with an address of 2567 CR 450E, Mahomet.

Site Area: **20.4 acres**

Time Schedule for Development: **In progress**

Prepared by: **Charlie Campo**, Senior Planner  
**John Hall**, Zoning Administrator

---

### **BACKGROUND**

The petitioners own a 20.44-acre tract that currently contains an artificial lake that is approximately 2.6 acres in area, a smaller artificial lake approximately .5 acres in area, a single-family residence under construction and accessory buildings.

The petitioner purchased the subject property in 2022. The property contained a single-family residence, accessory buildings, and two artificial lakes. The previous residence was demolished in 2023. The petitioner submitted a Zoning Use Permit Application for the construction of a new single-family residence on the property in April of 2024. The petitioner was informed that all artificial lakes greater than one acre in area require an approved Special Use Permit. The existing lake was constructed by the previous owner of the property without a Special Use Permit. The existing 2.6-acre lake requires a Special Use Permit approved by the Champaign County Zoning Board of Appeals to bring the property into conformance with the Zoning Ordinance. The petitioner applied for a Special Use Permit on June 25, 2024. No changes to the existing lake are proposed.

The property has been used as a single-family residence since the previous house was constructed in 1996. The lake appears to have been constructed between 2002 and 2005.

The P&Z Department has not received any comments regarding the proposed Special Use Permit.

### **EXTRATERRITORIAL JURISDICTION**

The subject property is not located within the one and one-half mile extraterritorial jurisdiction of a municipality with zoning.

continued

Brookens Administrative  
Center

1776 E. Washington Street  
Urbana, Illinois 61802

(217) 384-3708

[zoningdept@co.champaign.il.us](mailto:zoningdept@co.champaign.il.us)

[www.co.champaign.il.us/zoning](http://www.co.champaign.il.us/zoning)

The subject property is located within Newcomb Township, which has a Plan Commission. Townships with Plan Commissions do not have protest rights on Special Use Permits; however, they do receive notice of such cases and they are invited to comment.

## EXISTING LAND USE AND ZONING

**Table 1. Land Use and Zoning in the Vicinity**

<b>Direction</b>	<b>Land Use</b>	<b>Zoning</b>
Onsite	Residential	CR Conservation-Recreation
North	Residential	CR Conservation-Recreation
East	Agriculture, Residential	AG-1 Agriculture
West	Residential, Agriculture	CR Conservation-Recreation
South	Residential	CR Conservation-Recreation

## PROPOSED SPECIAL CONDITIONS

- A. **The artificial lake shall be added to Zoning Use Permit #120-24-01 for the single-family residence.**

The above special condition is required to ensure the following:

**The establishment of the proposed use shall be properly documented as required by the Zoning Ordinance.**

## ATTACHMENTS

- A Case Maps (Location, Land Use, Zoning)
- B Site Plan and Driveway Plan received June 25, 2024
- C Email from Petitioners Engineer received June 10, 2024
- D Pond Routing and Pond Calculation information from Petitioners Engineer received June 10, 2024
- E Annotated Aerial Photos 1988, 2002, 2005, 2023, 2013 floodplain
- F Site Images taken July 16, 2024
- G Draft Summary of Evidence, Finding of Fact, and Final Determination for Case 143-V-24 dated July 25, 2024





# Location Map

Case 146-S-24

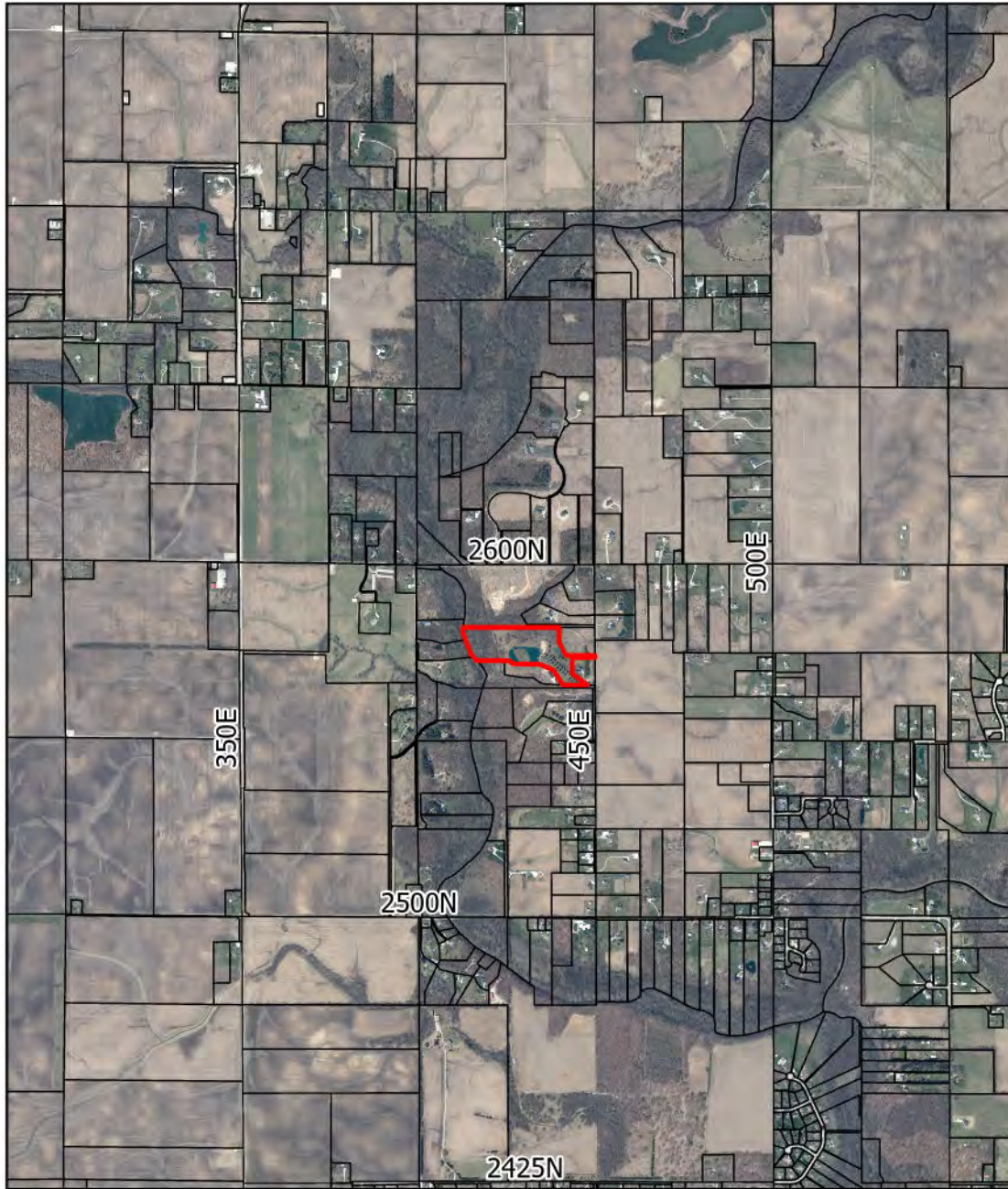
July 25, 2024



-  Subject Property
-  Municipal Boundary

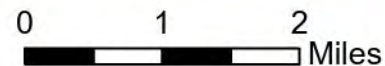
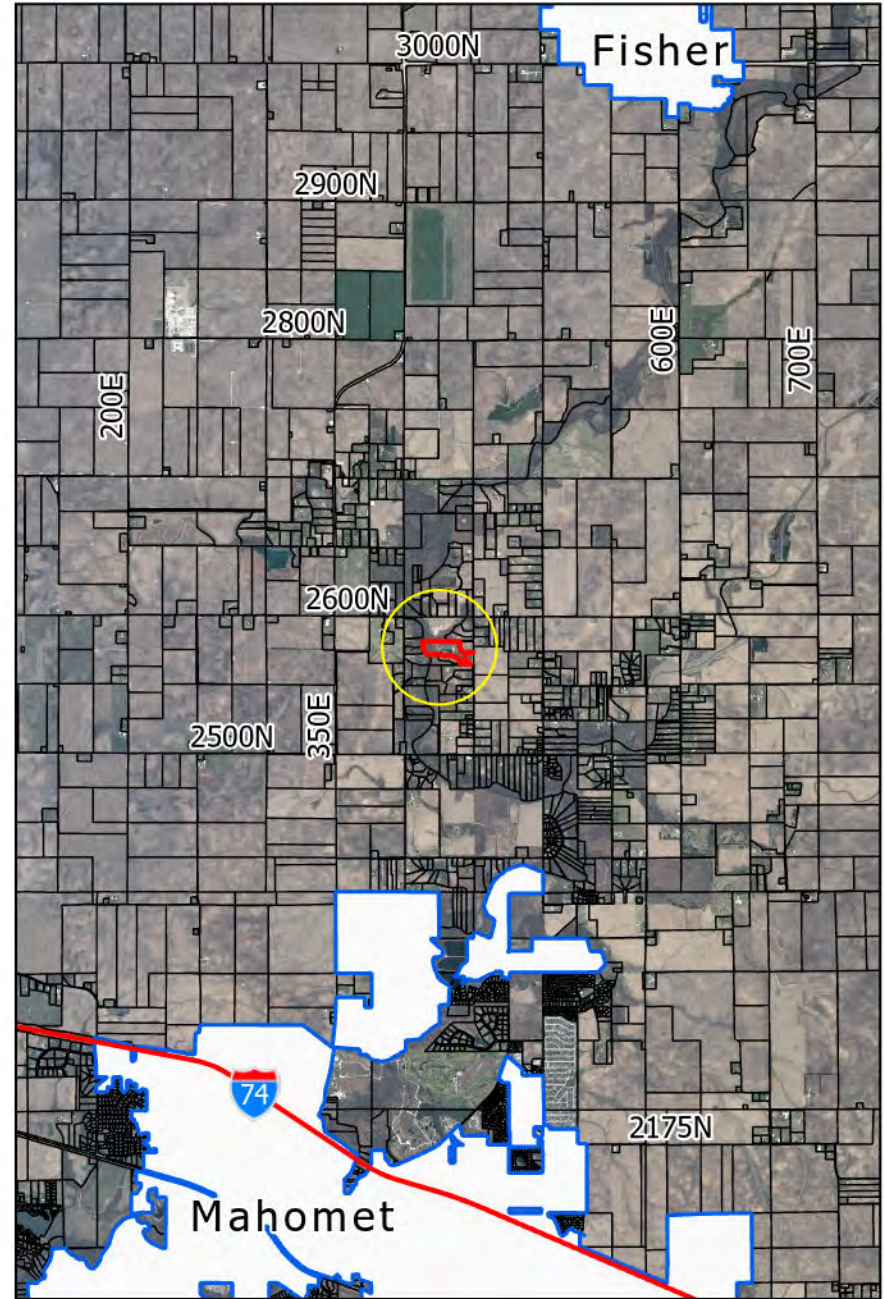
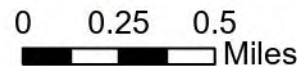



# Land Use Map

Case 146-S-24

July 25, 2024

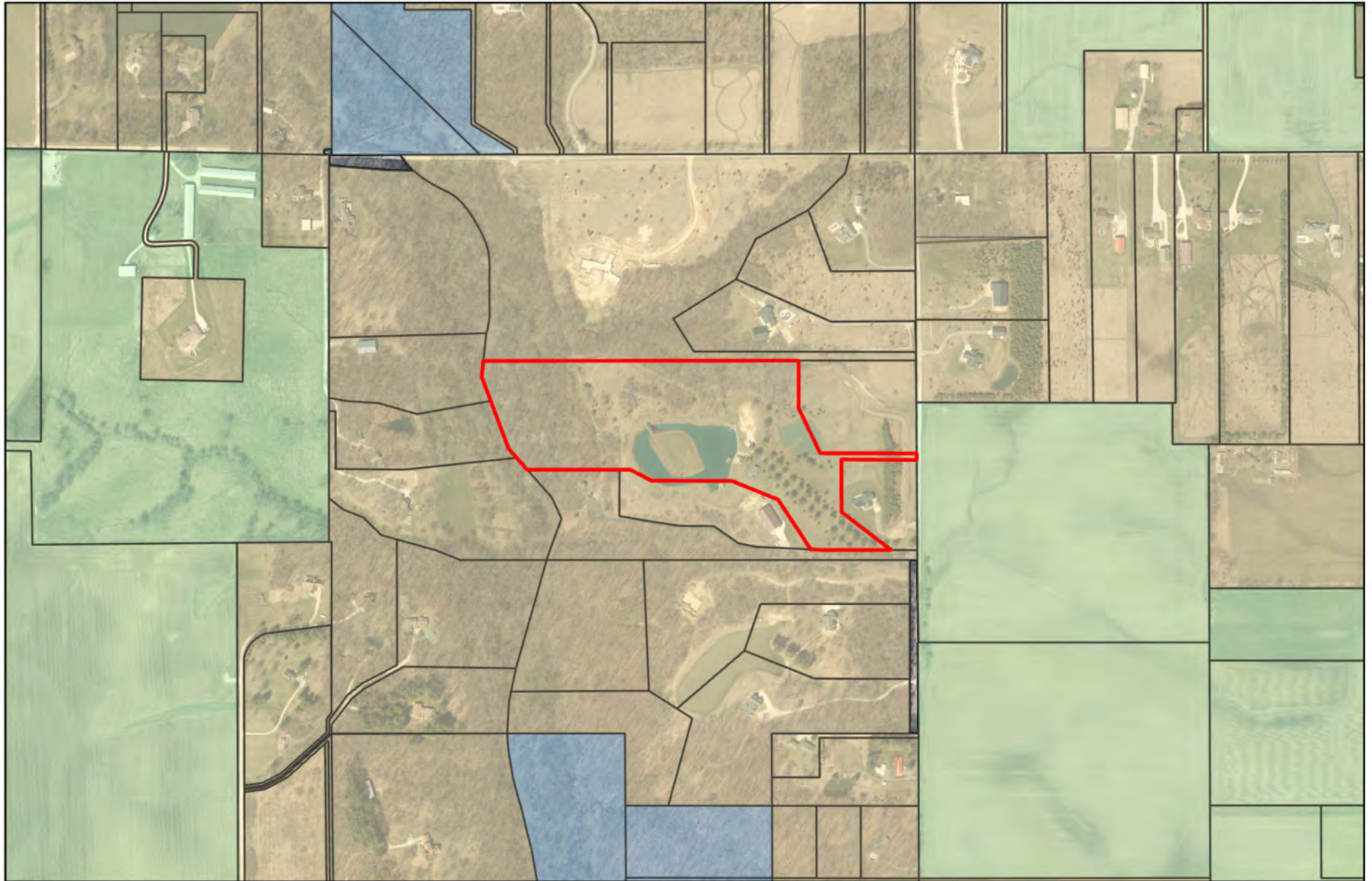

 Subject Property

 Agriculture

 Forest Preserve

 Residential

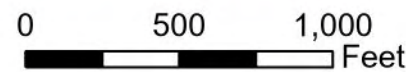



# Zoning Map

Case 146-S-24

July 25, 2024

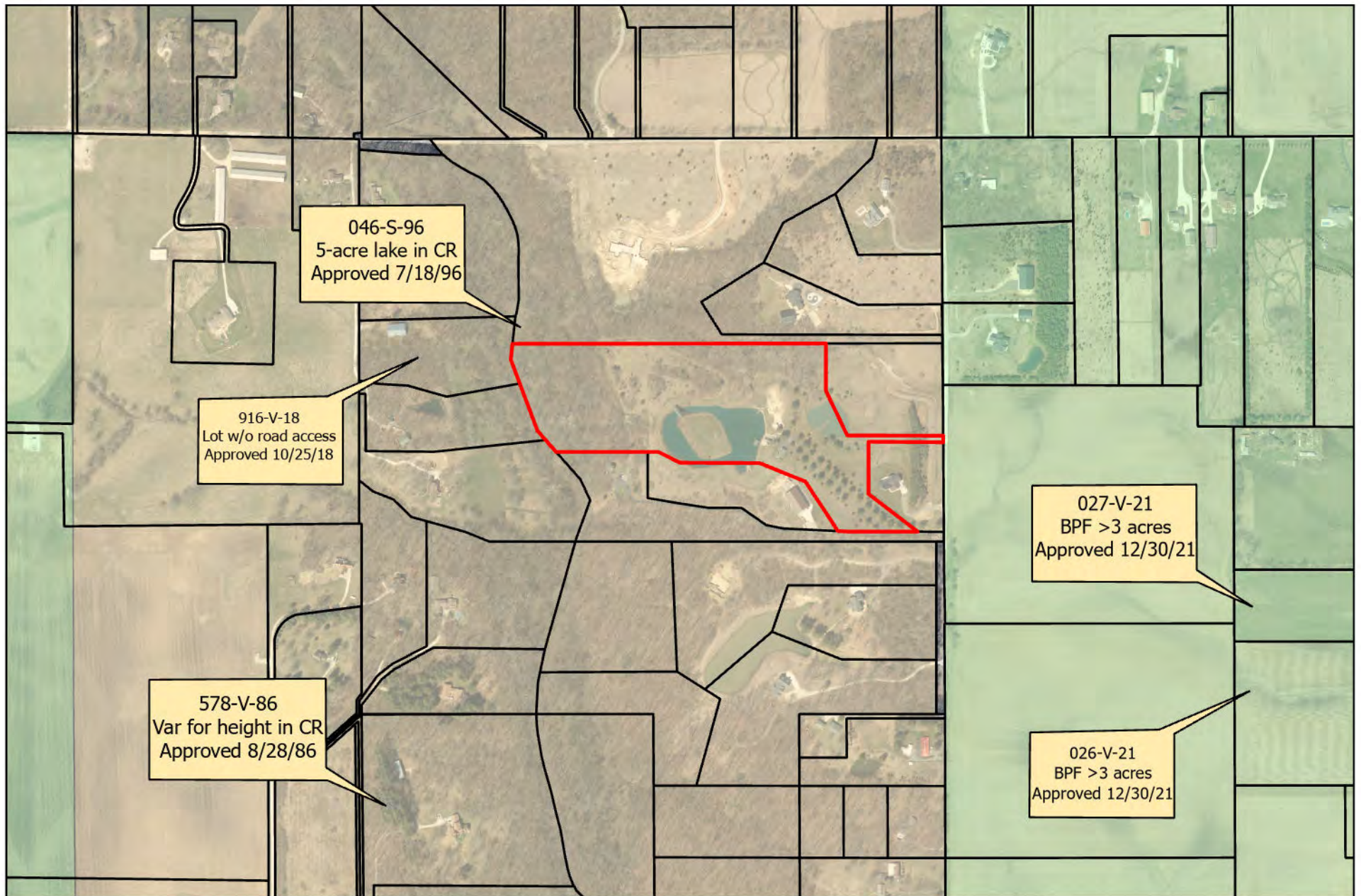

 Subject Property

 CR Conservation & Recreation

 AG-1 Agriculture

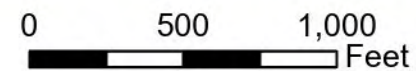



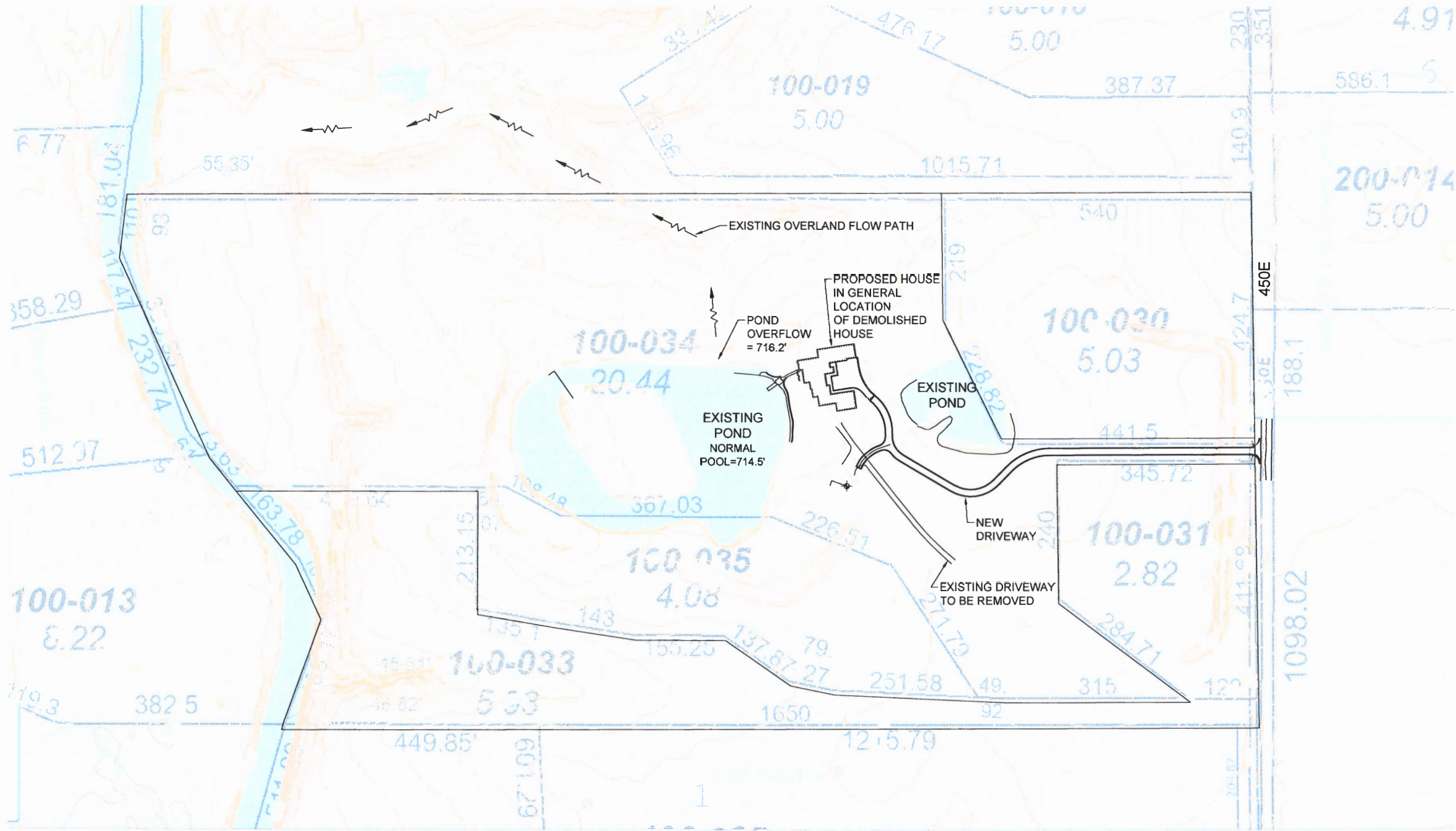

**RECEIVED**

**JUN 25 2024**

CHAMPAIGN CO. P & Z DEPARTMENT

File Name: S:\000 Projects\349 Steve and Christine Hillard\34924004 Hillard Driveway Plan\CAD\34924004.dwg

**BENCHMARK DATA:**

BM #1 = CHISELED SQUARE ON THE  
NORTHEAST CORNER OF THE CONCRETE  
PAD ON NORTH SIDE OF CAR GARAGE.  
ELEVATION = 722.15'

REV. #	REV. DATE:	REVISION MADE:
DATE:	06/19/24	SCALE: AS SHOWN
FIELD BOOK:	50p. 36-37	DRAWN BY: MAM
CHECKED BY:	MEI	
<b>OVERALL SITE PLAN</b>		
HILLARD TRACT PART OF SEC. 26, T.21 N., R. 7 E., 3rd P.M. CHAMPAIGN COUNTY, ILLINOIS		 <b>PRECISION ENGINEERING GROUP, INC.</b> P.O. BOX 784 CHAMPAIGN, IL 61824-0784 PHONE: 217.202.8049 CIVIL ENGINEERING - LAND SURVEYING ILLINOIS DESIGN FIRM REGISTRATION NO. 184007585
		FILE # <b>34924004</b> SHEET <b>1 OF 4</b>

# CIVIL ENGINEERING PLANS FOR HILLARD RESIDENCE DRIVEWAY CHAMPAIGN COUNTY, ILLINOIS A PART OF THE SECTION 26, T.21 N, R7E, OF THE 3rd P.M.

**GENERAL CONSTRUCTION NOTES**

1. All grading, sewer, pavement work and any other miscellaneous work shall be performed in accordance with the current edition of the Illinois Department of Transportation "Standard Specifications for Road and Bridge Construction" and the current edition of the "Standard Specifications for Water and Sewer Main Construction in Illinois", the current municipality's ordinances and any governing utility company's ordinances. In case of conflict, the most stringent shall hold.
2. The Contractor is responsible to maintain the vertical grades and the horizontal alignment as shown on the plans for all storm sewers, pavement and other site improvements.
3. All labor, equipment, and materials called for in these plans or specifications shall be furnished by the selected Contractor as necessary in order to complete all construction of the various improvements.
4. All Contractors shall obtain any necessary excavation permits, drive permits, land disturbance permits, necessary bonds from the local municipality and all required insurance coverage prior to beginning any construction activities. Copies shall be provided to the Owner. Attention is called to current municipal, County, State and Federal Safety Regulations and Guidelines. Contractors shall be familiar with these regulations and guidelines and shall strictly adhere to them.
5. Contractors shall take care to maintain the site and adjacent areas in as clean a condition as possible. Any dirt, mud or construction debris shall be cleaned daily, or as the Owner directs, from any adjoining streets or properties by the responsible contractor as a part of the primary construction work. There shall be no additional compensation to the Contractor.
6. All work, including materials, workmanship and methods shall be guaranteed by the Contractor for 12 months after job completion and fully acceptance by the Owner. Any defects discovered during that 12 month period shall be promptly repaired or corrected by the Contractor at no additional cost to the Owner.
7. Any trench settlement causing pavement cracking and/or settlement shall be repaired and the pavement properly replaced by the sewer contractor within two weeks of notification by the Owner.
8. The Contractor shall dispose of excess excavated material on site.

**SITE GRADING NOTES**

1. Refer to the "General Construction Notes".
2. All earth excavation work shall conform to Section 202 of the Standard Specifications for Road and Bridge Construction. Earth quantities are to be paid for as in original state (i.e., compacted condition).
3. All borrow and imported material shall conform to Section 204 of the Standard Specifications for Road and Bridge Construction unless otherwise noted.
4. All stripped topsoil shall be placed over disturbed or filled areas and graded smooth. No earthen clods larger than 3" in diameter shall be accepted. All organic soil material shall be removed from the pavement subgrade and building pad area.
5. All disturbed areas shall be seeded and/or have siltation barriers applied as shown on these plans as soon as final grading has been completed.
6. Contractor shall be responsible for any damage to storm and sanitary sewers due to earthwork operations.
7. The entire subgrade shall be compacted to not less than 95% of the standard laboratory density.
8. All excavation, fine grading, embankment work, seeding, necessary watering and mulching shall be a part of the seeding work and shall be considered in the unit price of seeding.
9. Finished grading shall be checked and approved by the Owner before seeding.

**STONE BASE NOTES**

1. Refer to the "General Construction Notes".
2. Aggregate base course shall be crushed stone and shall be Type A. Base Course aggregate shall be CA-6 material. All aggregate crushed stone base course construction shall conform to Section 351 of the Standard Specifications for Road and Bridge Construction.
3. The base course shall be constructed in layers not more than 4 inches thick. The aggregate shall be deposited directly on the prepared subgrade or on the preceding layer of compacted aggregate with a spreader. When placed, it shall be free from segregation and shall require minimum blading or manipulation. Immediately after the material has been placed, it shall be compacted with a tamping roller or with a pneumatic-tired roller, or with a vibratory machine, or with a combination of any of the three. The top layer shall be given a final rolling with a three-wheel or tandem roller.
4. Before the aggregate is deposited on the subgrade, it shall contain the amount of moisture required for compaction.
5. If density tests indicate that the base course does not comply with the density requirements, additional wetting if necessary, and rolling will be required until the density is obtained. Moisture shall be added to the material during compaction only when it is necessary to obtain the required density.
6. Aggregate used for base course will be measured for payment in square yards of the thickness specified.
7. Water required to be added for compaction on the grade will not be measured for payment but shall be considered as incidental to the work.
8. Aggregate base courses shall have a minimum in-place density of 95%, with no individual test below 95%.

**PAVEMENT AND SIDEWALK NOTES**

1. Refer to the "General Construction Notes".
2. Prior to placing pavement, certain subgrade areas may require some additional grading, compaction, or stabilization by the Contractor. This shall be at no additional compensation to the Contractor unless such area exceeds 24 SY in each case.
3. Lime modified soils shall consist of the construction of a 12" thick modified soil layer composed of soil, lime and water. Lime shall not be applied to or mixed with frozen soil. Soils shall be modified in accordance with Article 302 of the Standard Specifications.  
Upon pavement completion, the Contractor shall backfill pavement edges.
4. Matching existing pavement shall be made with either a construction or expansion joint.
5. Portland Cement Concrete (PCC):  
All Portland Cement Concrete paving shall be constructed in accordance with Article 420 of the IDOT Standard Specifications. Material for PCC shall have a maximum allowable slump of 4 inches. The concrete shall have an air entrainment of not less than 5% or more than 8% by volume. The concrete shall attain a compression strength of 3500 psi at the age of 14 days when tested by standard methods for all pavement and sidewalks.
6. PCC Pavement:
  - a) All pavement removals shall be accomplished with a full depth saw cut. A minimum 2-foot bench shall be maintained on all sides of an open excavation. Subgrade shall be compacted to the satisfaction of the governing body and if necessary, repaired with granular backfill as necessary.
  - b) All concrete patches and repairs of defects shall be made with IDOT Class C patches with the exception of patches on Arterial and Major Collector street. Arterial and Major Collector streets 8 inches or greater in depth shall be repaired with a modified IDOT Class B patch. One-inch deformed reinforcing bars shall be substituted for smooth dowels at any new mid-panel joint. Smooth dowel bars shall be used at any preexisting contraction joint. Preexisting contraction joints shall be replaced with an appropriate grooving tool. Concrete patch width shall coincide with the edge of full panels and shall have a minimum longitudinal distance of 6 feet. In large cuts, full panels shall be removed and replaced.
  - c) Construct contraction joints in the pavement and curb and gutter every 12 feet or less. Joint inserts or dummy joints are strictly prohibited. Sawing of all joints shall commence as soon as the concrete has hardened sufficiently to permit sawing without excessive releveling, but no later than 8 hours after concrete is poured in place. All pavement joints shall line up with curb and gutter joints.
  - d) Where there are no vertical curves, round off the PVI areas. Transitions in these areas should be (5) five feet in each direction of the PVI point.
10. Any undersigned cracks in the pavement considered to be a defect but not considered for removal shall be routed and sealed in accordance with the ordinance.

**SHEET INDEX**

- |   |                        |
|---|------------------------|
| 1 | COVER & SPECIFICATIONS |
| 2 | EAST DRIVEWAY PLAN     |
| 3 | EAST PROFILE           |
| 4 | WEST DRIVEWAY PLAN     |
| 5 | WEST PROFILE           |

Signed:



Mark A. Miller  
Illinois Licensed Professional Engineer  
No. 062.056290  
License Expires 11/30/25



Date:

06/21/24

RECEIVED

JUN 25 2024

CHAMPAIGN CO. P & Z DEPARTMENT

REV. #	REV. DATE:	REVISION MADE:		<b>PRECISION ENGINEERING GROUP, INC.</b> P.O. BOX 784 CHAMPAIGN, IL 61824-0784 PHONE: 217.202.8049 CIVIL ENGINEERING - LAND SURVEYING ILLINOIS DESIGN FIRM REGISTRATION NO. 184007585	
DATE:	06/21/24	SCALE:			AS SHOWN
FIELD BOOK:	50/p. 36-37	DRAWN BY:			MAM
CHECKED BY:	MEI				
COVER & SPECIFICATIONS					
HILLARD TRACT PART OF SEC. 26, T.21 N., R. 7 E., 3rd P.M. CHAMPAIGN COUNTY, ILLINOIS			FILE # 34924004	SHEET 1 OF 5	



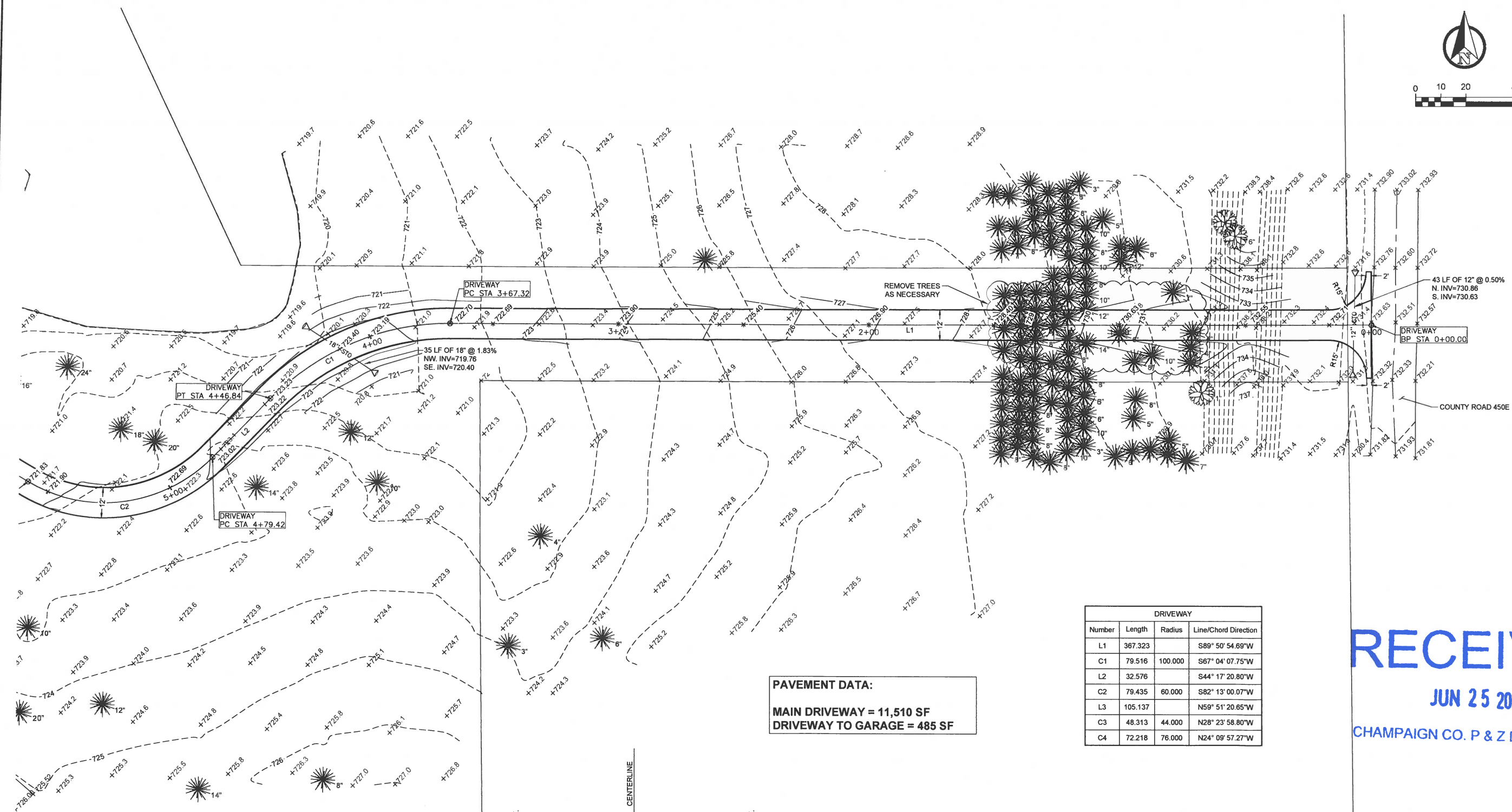
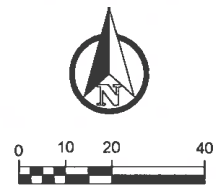

**PAVEMENT DATA:**  
 MAIN DRIVEWAY = 11,510 SF  
 DRIVEWAY TO GARAGE = 485 SF

DRIVEWAY			
Number	Length	Radius	Line/Chord Direction
L1	367.323		S89° 50' 54.69"W
C1	79.516	100.000	S67° 04' 07.75"W
L2	32.576		S44° 17' 20.80"W
C2	79.435	60.000	S82° 13' 00.07"W
L3	105.137		N59° 51' 20.65"W
C3	48.313	44.000	N28° 23' 58.80"W
C4	72.218	76.000	N24° 09' 57.27"W

**RECEIVED**  
 JUN 25 2024  
 CHAMPAIGN CO. P & Z DEPARTMENT

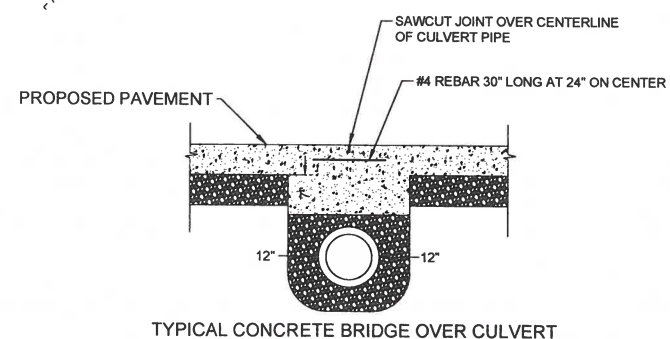

- NOTES:**
1. ALL TRANSVERSE CONTRACTION JOINTS MUST BE CONTINUOUS ACROSS PAVEMENT.
  2. MAXIMUM TRANSVERSE CONTRACTION JOINT SHALL BE 12 FEET.
  3. ALL JOINTS SHALL BE SEALED.

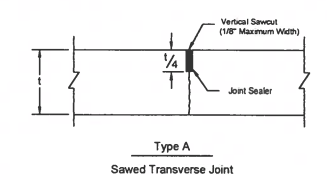
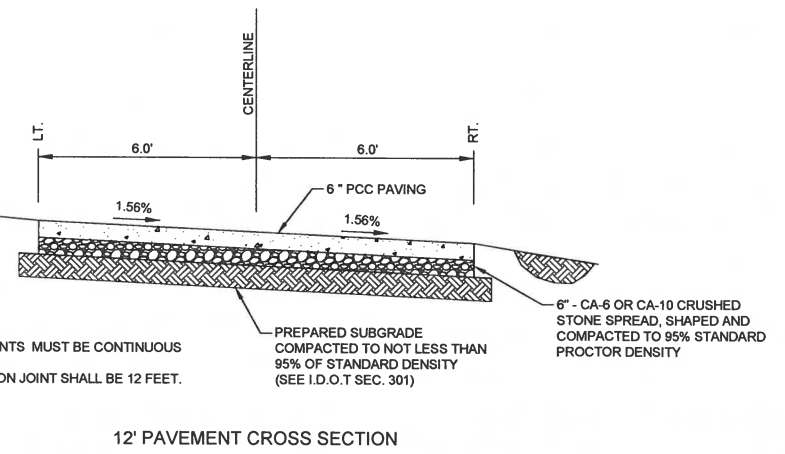

REV. #	REV. DATE:	REVISION MADE:
DATE:	06/21/24	SCALE: AS SHOWN
FIELD BOOK:	50/p. 36-37	DRAWN BY: MAM
CHECKED BY:	MEI	
<b>DRIVEWAY PLAN (EAST)</b>		
HILLARD TRACT PART OF SEC. 26, T.21 N., R. 7 E., 3rd P.M. CHAMPAIGN COUNTY, ILLINOIS		
FILE #		34924004
SHEET		2 OF 5

**PRECISION ENGINEERING GROUP, INC.**  
 P.O. BOX 784 CHAMPAIGN, IL 61824-0784  
 PHONE: 217.202.8049  
 CIVIL ENGINEERING - LAND SURVEYING  
 ILLINOIS DESIGN FIRM REGISTRATION NO. 184007595

File Name: S:\000\Projects\349 Steve and Christine Hillard\34924004 Hillard Driveway Plan\CAD\34924004.dwg



SCALE:  
 HORZ. 1"=20'  
 VERT. 1"=2'

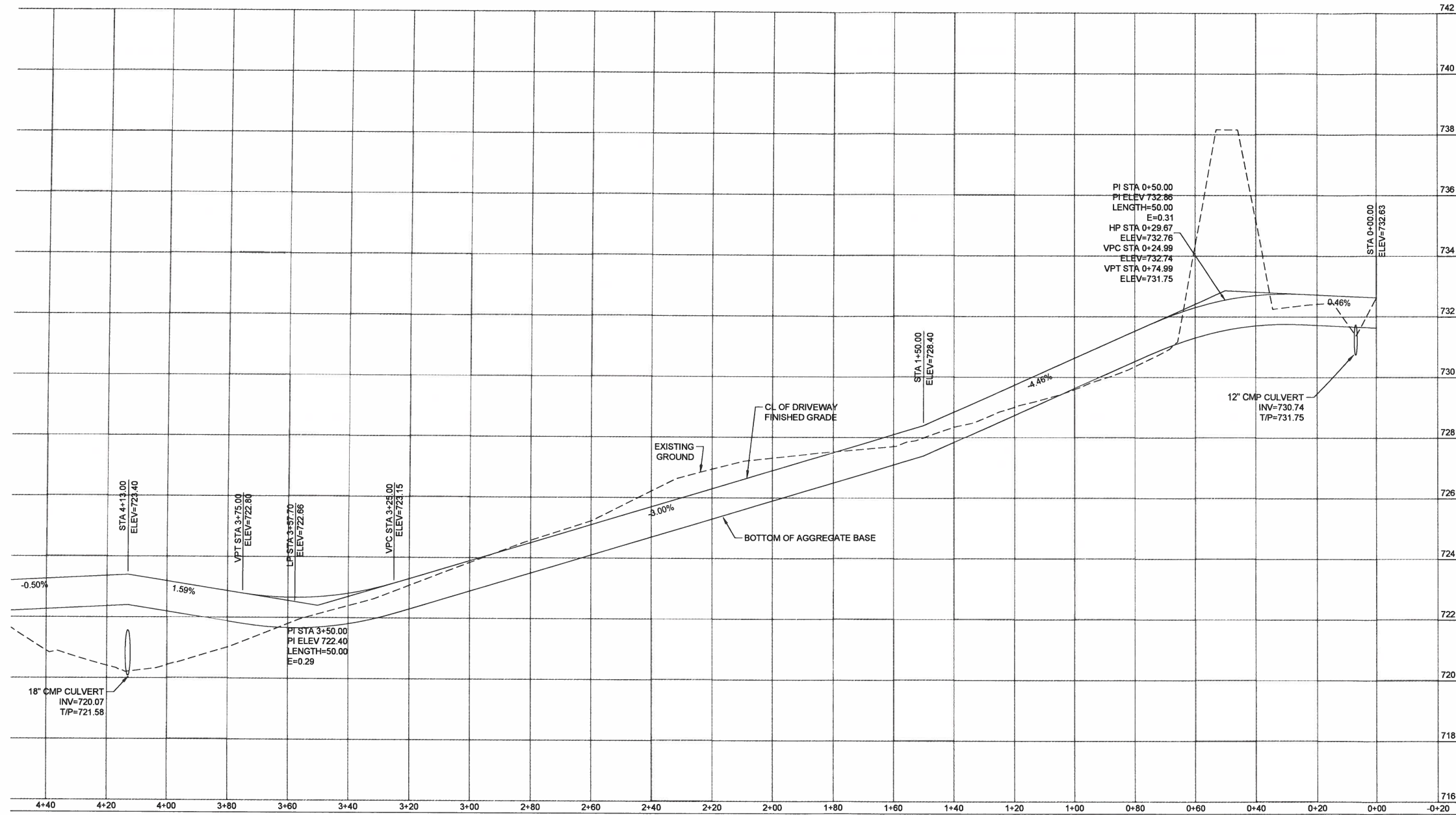

**RECEIVED**  
 JUN 25 2024  
 CHAMPAIGN CO. P & Z DEPARTMENT

File Name: S:\000 Projects\348 Stone and Christine Hillard\34824004 Hillard Driveway Plan\CD\34824004.dwg

REV. #	REV. DATE:	REVISION MADE:
DATE:	06/21/24	SCALE: AS SHOWN
FIELD BOOK:	50/p. 36-37	DRAWN BY: MAM
CHECKED BY:	MEI	
<b>DRIVEWAY PROFILE (EAST)</b>		
HILLARD TRACT PART OF SEC. 26, T.21 N., R. 7 E., 3rd P.M. CHAMPAIGN COUNTY, ILLINOIS		FILE # 34924004 SHEET 3 OF 5
PRECISION ENGINEERING GROUP, INC. P.O. BOX 784 CHAMPAIGN, IL 61824-0784 PHONE: 217.202.8049 CIVIL ENGINEERING - LAND SURVEYING ILLINOIS DESIGN FIRM REGISTRATION NO. 184007585		

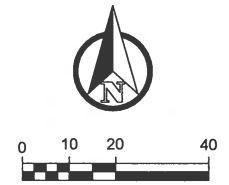

DRIVEWAY			
Number	Length	Radius	Line/Chord Direction
L1	367.323		S89° 50' 54.69"W
C1	79.516	100.000	S67° 04' 07.75"W
L2	32.576		S44° 17' 20.80"W
C2	79.435	60.000	S82° 13' 00.07"W
L3	105.137		N59° 51' 20.65"W
C3	48.313	44.000	N28° 23' 58.80"W
C4	72.218	76.000	N24° 09' 57.27"W

**PAVEMENT DATA:**  
**MAIN DRIVEWAY = 11,510 SF**  
**DRIVEWAY TO GARAGE = 485 SF**

**RECEIVED**  
 JUN 25 2024  
 CHAMPAIGN CO. P & Z DEPARTMENT

**BENCHMARK DATA:**  
 BM #1 = CHISELED SQUARE ON THE NORTHEAST CORNER OF THE CONCRETE PAD ON NORTH SIDE OF CAR GARAGE.  
 ELEVATION = 722.15'

REV. #	REV. DATE:	REVISION MADE:
DATE:	06/21/24	SCALE: AS SHOWN
FIELD BOOK:	50/p. 36-37	DRAWN BY: MAM
CHECKED BY:	MEI	

**PRECISION ENGINEERING GROUP, INC.**  
 P.O. BOX 784 CHAMPAIGN, IL 61824-0784  
 PHONE: 217.202.8049  
 CIVIL ENGINEERING - LAND SURVEYING  
 ILLINOIS DESIGN FIRM REGISTRATION NO. 184007585

<b>DRIVEWAY PLAN (WEST)</b> HILLARD TRACT PART OF SEC. 26, T.21 N., R. 7 E., 3rd P.M. CHAMPAIGN COUNTY, ILLINOIS	FILE # <b>34924004</b> SHEET <b>4 OF 5</b>
---	---

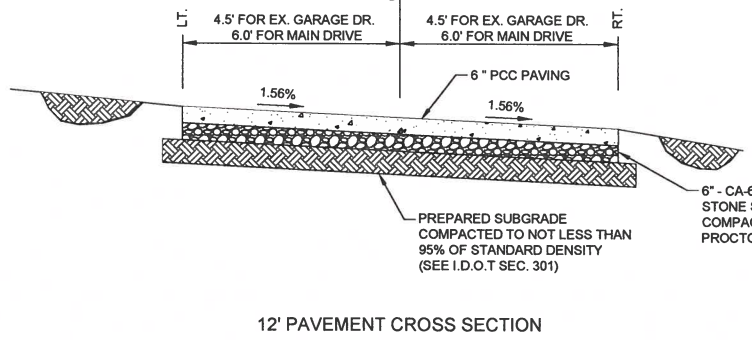
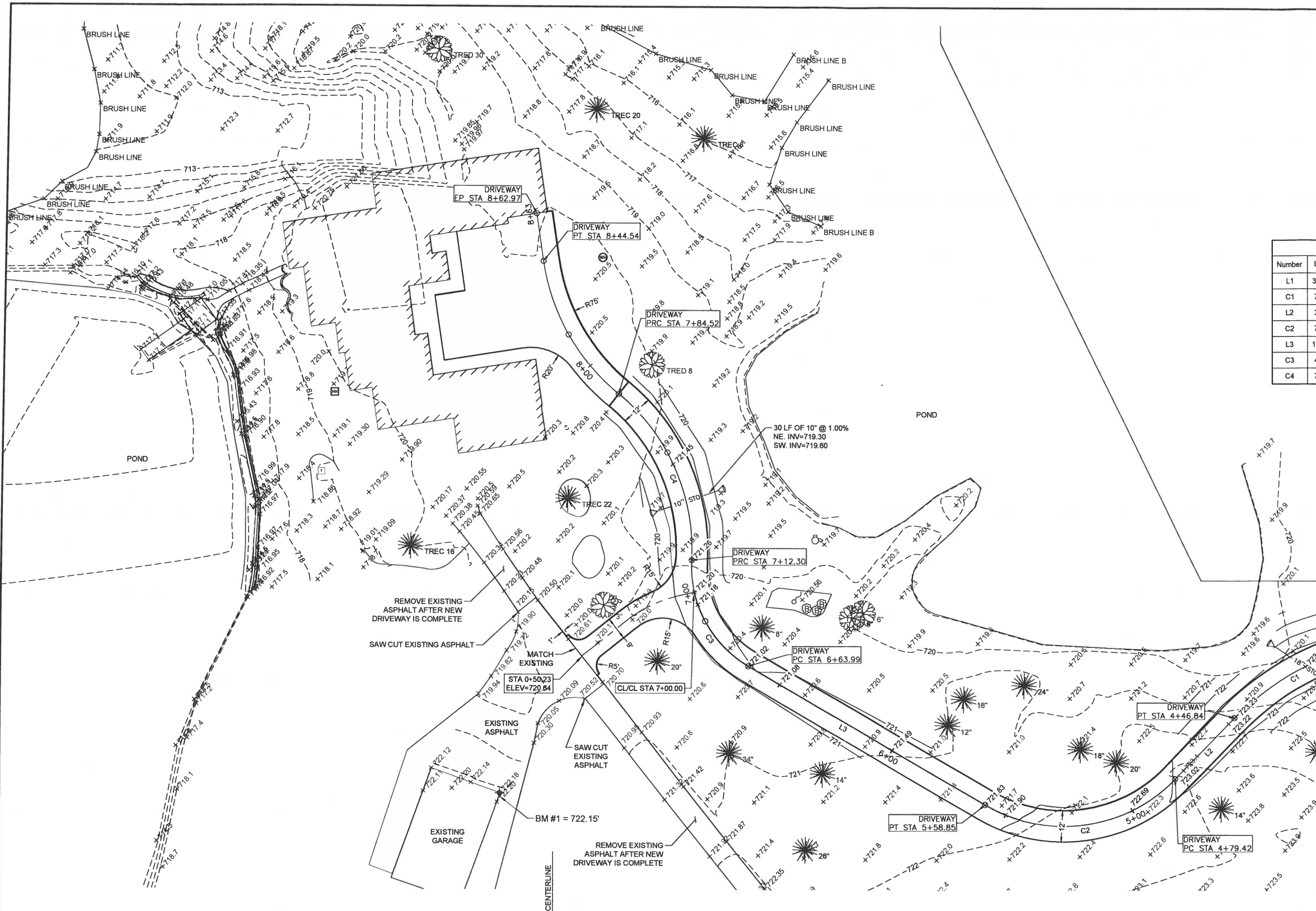

- NOTES:**
1. ALL TRANSVERSE CONTRACTION JOINTS MUST BE CONTINUOUS ACROSS PAVEMENT.
  2. MAXIMUM TRANSVERSE CONTRACTION JOINT SHALL BE 12 FEET.
  3. ALL JOINTS SHALL BE SEALED.

File Name: S:\000 Projects\349 Steve and Christine Hillard\34924004 Hillard Driveway Plan\CAD\34924004.dwg



SCALE:  
 HORZ. 1"=20'  
 VERT. 1"=2'

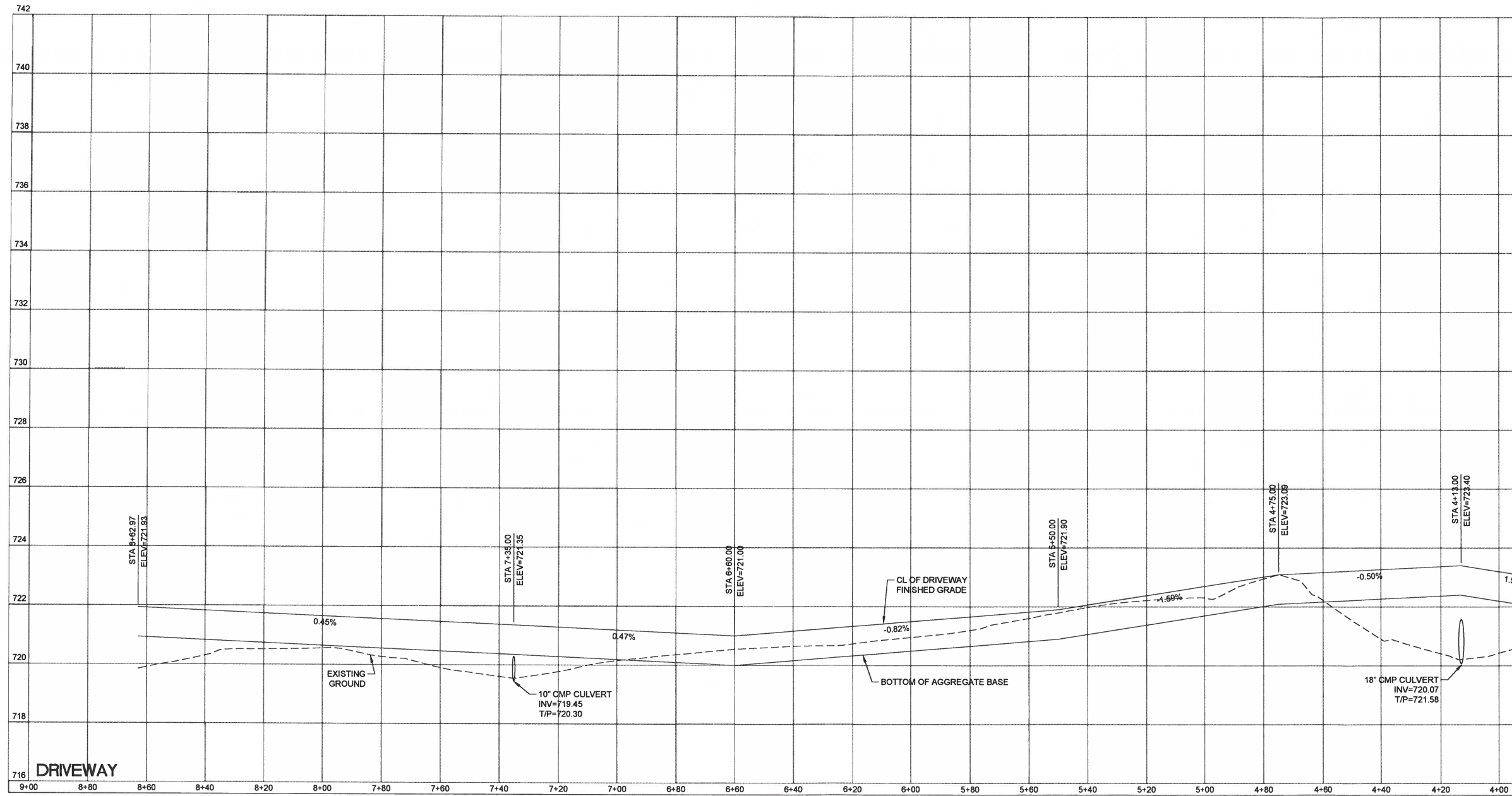

RECEIVED  
 JUN 25 2024  
 CHAMPAIGN CO. I

REV. #	REV. DATE:	REVISION MADE:
DATE:	06/21/24	SCALE: AS SHOWN
FIELD BOOK:	50/p. 36-37	DRAWN BY: MAM
CHECKED BY:	MEI	
<b>DRIVEWAY PROFILE (WEST)</b>		
HILLARD TRACT PART OF SEC. 26, T.21 N., R. 7 E., 3rd P.M. CHAMPAIGN COUNTY, ILLINOIS		FILE # 34924004 SHEET 5 OF 5

  
**PRECISION ENGINEERING GROUP, INC.**  
 P.O. BOX 784 CHAMPAIGN, IL 61824-0784  
 PHONE: 217.202.8049  
 CIVIL ENGINEERING - LAND SURVEYING  
 ILLINOIS DESIGN FIRM REGISTRATION NO. 184007585

## Charles W. Campo

---

**From:** John Hall  
**Sent:** Wednesday, July 3, 2024 1:52 PM  
**To:** Charles W. Campo  
**Subject:** FW: Hillard Existing Basin - Mahomet, IL  
**Attachments:** pond routing.pdf; pond calcs.pdf

**Importance:** High

Charlie, here is supplementary info that should be added to the evidence for Case 146-S-24.

---

**From:** Merle Ingersoll <merle@precisioneg.com>  
**Sent:** Monday, June 10, 2024 5:15 PM  
**To:** John Hall <jhall@champaigncountyil.gov>  
**Cc:** Steve Hillard <steve.hillard03@gmail.com>; Mark Miller <mark@precisioneg.com>  
**Subject:** Hillard Existing Basin - Mahomet, IL  
**Importance:** High

**CAUTION:** External email, be careful when opening.

John,

Below are my responses in blue to your previous questions. If after your review, you think you need more, let us know. I don't think it will ever overflow and has no real outlet pipe. If this is good enough to submit for approval, let us know that too. I assume this is in time for any hearings or reviews.

Does there need to be any armoring on the emergency overflow to prevent erosion and sedimentation?

There is approximately 5.32 acres that will drain to the existing pond. We don't believe from our calculations on the existing pond that there needs to be anything more than what is there now. The new paving, home and the pond all were considered impervious and it raised the pond very little in a 100 year storm only 0.25 feet (3 inches). The overflow is a grass weir or low point on the North side.

It looks like the overflow would go onto the neighboring property to the north- is that the original direction that runoff would flow or has the construction of the pond changed the surface flows? Has the pond increased the amount of runoff that goes to that property? Will overflows likely create any problem on that property?

The natural overland flow drained to the North and still does. The area that it will overflow is on the North side of the pond is at the same location. If it ever did overflow, it would go down into a natural ravine and drain Northwest to the Sangamon River. From inspection of the site, there appears to be no erosion and probably will never overtop.

The natural pond level is around 714.50 feet with the low point of the bank at 717.00 feet on the North side where the grass overflow area is located. The pond has approximately 5.0 Ac-Ft or 217,800 cubic feet of storage. In a 100 year storm, it raised to 714.75 feet, only 0.25 feet using 21,396 cubic feet of storage. It would have to have approx. ten consecutive 100 storm events before it would overtop.



The owner (Steve Hillard) has indicated that it has never overflowed to his knowledge and he usually needs to pump well water into it to raise it enough to make it look nice whenever it gets too low. There is no outlet pipe and therefore just fills up with storm water and evaporates over time.

If you think that a simpler hydraulic analysis of the discharge will answer all the questions you could request a waiver from the hydraulic analysis, so long as a simpler explanation can ease any concerns about possible property damage.

Attached are some simple storm calcs and routing of the overflow for your review to go along with the responses I've provided here in this email.

This will be a Special Use Permit hearing at the Zoning Board of Appeals. We are currently taking cases for the July 11, 2024, meeting and will need the application no later than June 17 for that hearing. The next ZBA meeting is July 25 and we will need an application by July 1 for that hearing.

Sincerely,

**PRECISION ENGINEERING GROUP, INC.**

Merle E. Ingersoll, Jr., PLS, PE  
Senior Project Manager  
P.O. Box 784  
Champaign, IL 61824-0784

Cell Phone: 217-840-7785 (Text only)  
Email: [merle@precisioneg.com](mailto:merle@precisioneg.com)  
Website: [www.precisioneg.com](http://www.precisioneg.com)



GIS Webmap Public Interface Champaign County, Illinois

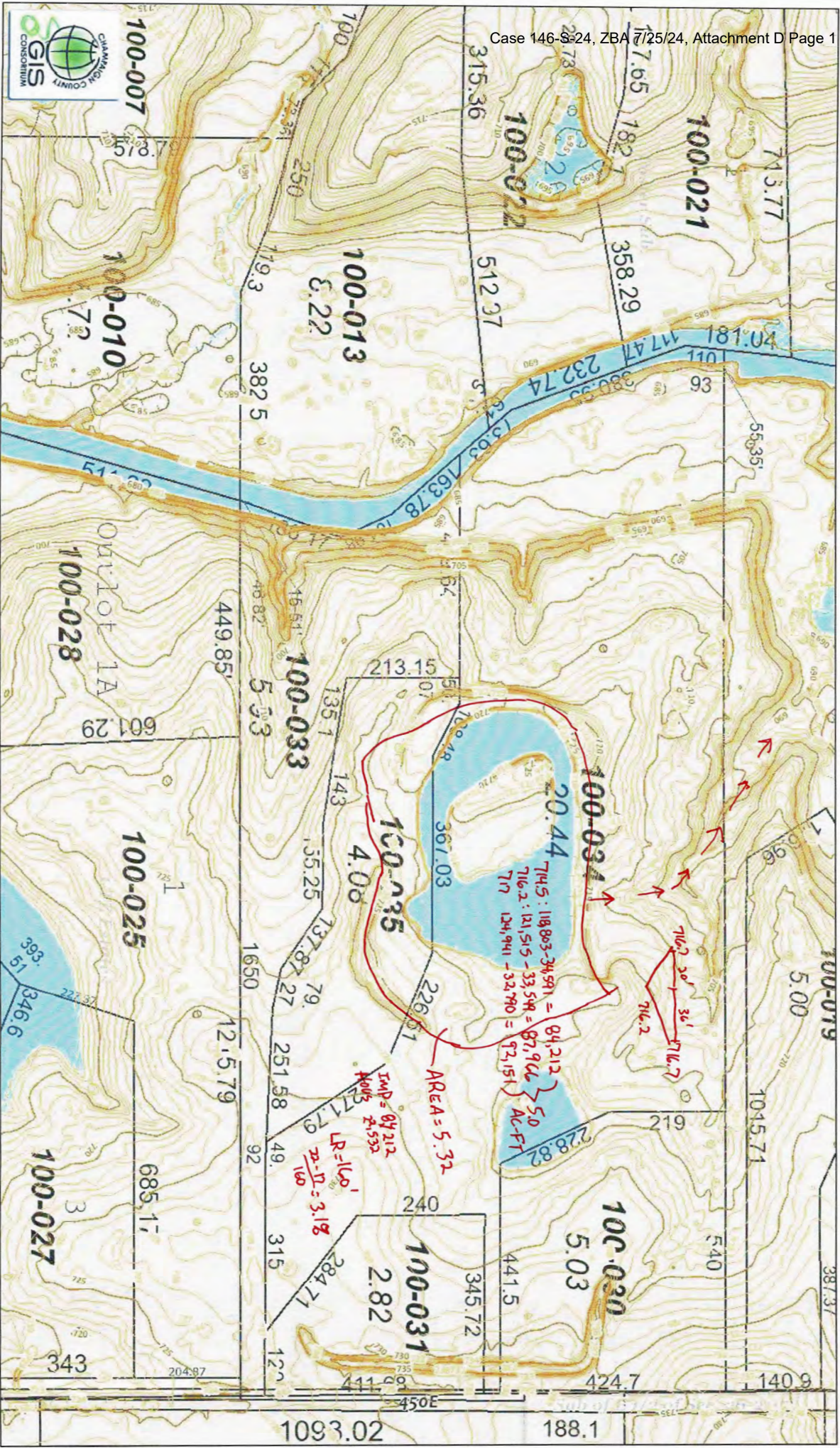

This map application was prepared with Geographic Information System (GIS) data created by the Champaign County GIS Consortium (CCGIS), or other CCGIS member agency. These entities do not warrant or guarantee the accuracy or suitability of GIS data for any purpose. The data within this application is intended to be used as a general index to spatial information and not intended for detailed, site-specific analysis or resolution of legal matters. Users assume all risk arising from the use or misuse of the application and information contained herein. The use of this application constitutes acknowledgment of this disclaimer.

100 Feet





# Hydrograph Summary Report

Hyd. No.	Hydrograph type (origin)	Peak flow (cfs)	Time interval (min)	Time to Peak (min)	Hyd. volume (cuft)	Inflow hyd(s)	Maximum elevation (ft)	Total strge used (cuft)	Hydrograph Description	
1	Rational	19.81	1	18	21,396	-----	-----	-----	Existing Area	
2	Reservoir	0.000	1	n/a	0	1	714.75	21,396	<no description>	
New.gpw					Return Period: 100 Year			Monday, 06 / 10 / 2024		

# Hydrograph Report

Hydraflow Hydrographs Extension for Autodesk® Civil 3D® by Autodesk, Inc. v2024

Monday, 06 / 10 / 2024

## Hyd. No. 2

<no description>

Hydrograph type	= Reservoir	Peak discharge	= 0.000 cfs
Storm frequency	= 100 yrs	Time to peak	= n/a
Time interval	= 1 min	Hyd. volume	= 0 cuft
Inflow hyd. No.	= 1 - Existing Area	Max. Elevation	= 714.75 ft
Reservoir name	= Existing Pond	Max. Storage	= 21,396 cuft

Storage Indication method used.

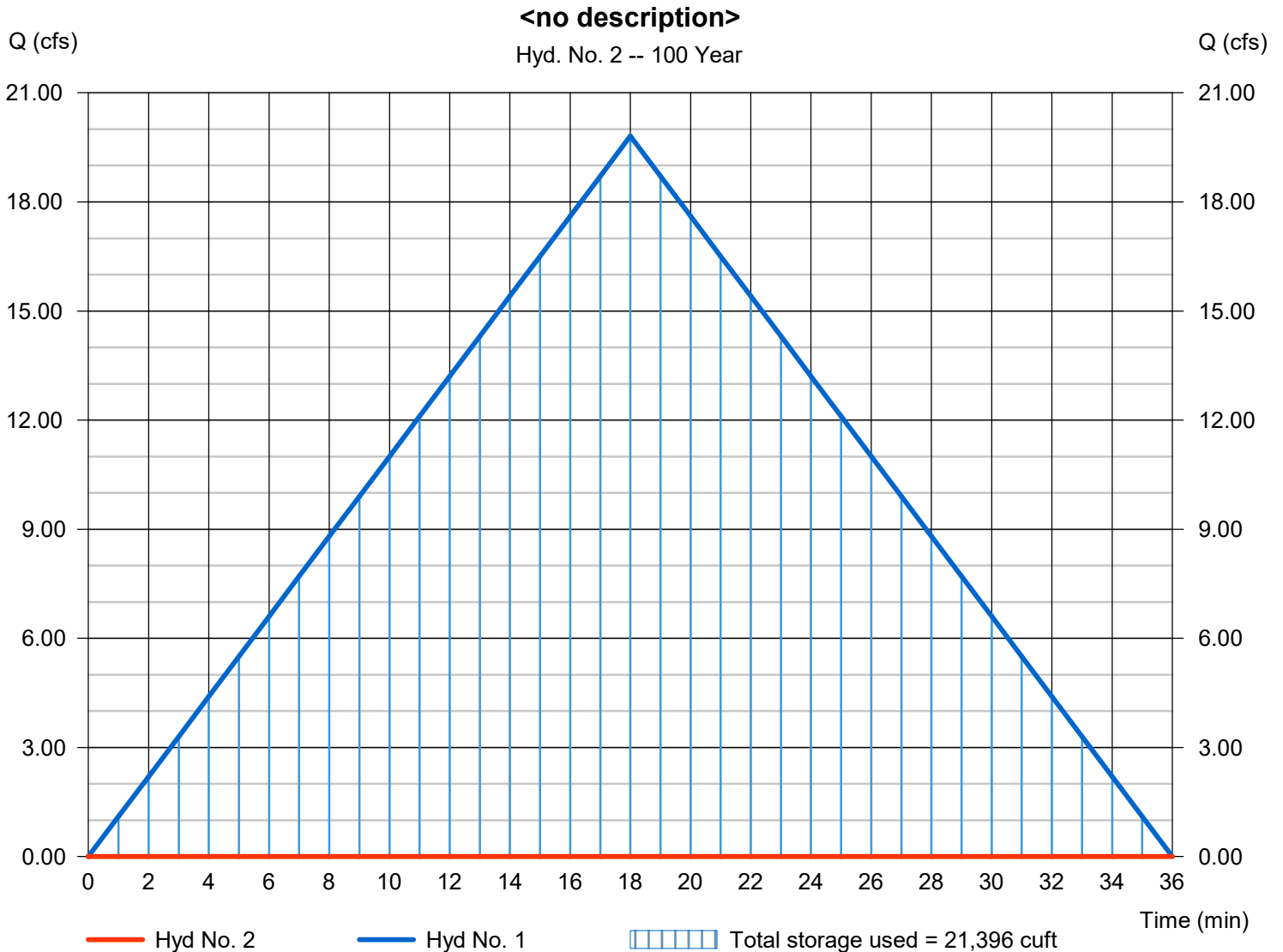



# Annotated 1988 Aerial

Case 146-S-24

July 25, 2024

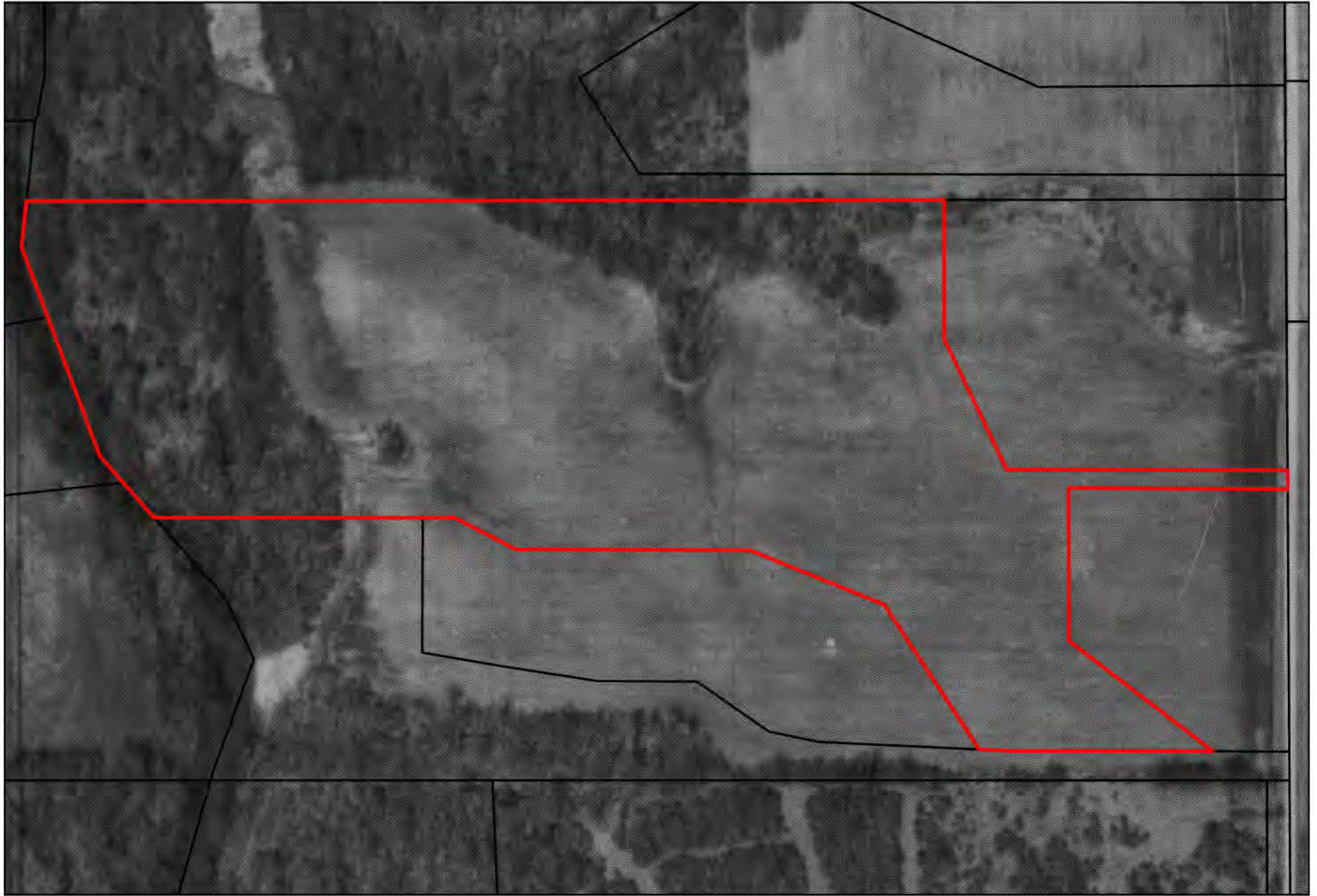

\*Property lines shown reflect current boundaries

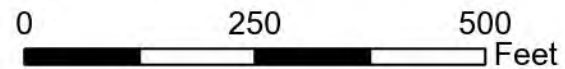



# Annotated 2002 Aerial

Case 146-S-24

July 25, 2024



\*Property lines shown reflect current boundaries

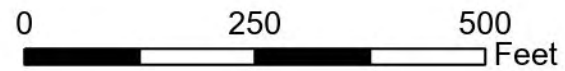





\*Property lines shown reflect current boundaries

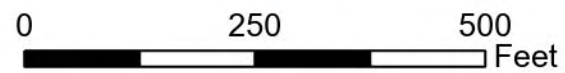



# Annotated 2023 Aerial

Case 146-S-24

July 25, 2024



\*Property lines shown reflect current boundaries

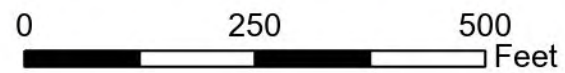



# Annotated 2013 Flood Zone Map

Case 146-S-24

July 25, 2024

# 2023 Aerial

Case 146-S-24, ZBA 7/25/24, Attachment E Page 5 of 5



CTZ Estates

Sources: Esri, TomTom, Garmin, FAO, NOAA, USGS, © OpenStreetMap contributors, and the GIS User Community, Champaign County GIS Consortium, DFIRM

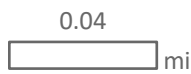

This map was prepared with geographic information system (GIS) data created by the Champaign County GIS Consortium (CCGISC), or other CCGISC member agency. These entities do not warrant or guarantee the accuracy or suitability of GIS data for any purpose. The GIS data within this map is intended to be used as a general index to spatial information and not intended for detailed, site-specific analysis or resolution of legal matters. Users assume all risk arising from the use or misuse of this map and information contained herein. The use of this map constitutes acknowledgement of this disclaimer.



Date: Friday, July 12, 2024



### 146-S-24 Site Images



**Facing N along 450E**



**From 450e facing SW toward new entrance location**



### 146-S-24 Site Images



From 450E facing W toward Subject Property



From 450E facing E

### 146-S-24 Site Images



Facing S along 450E



**PRELIMINARY DRAFT**

**146-S-24**

**SUMMARY OF EVIDENCE, FINDING OF FACT  
AND FINAL DETERMINATION  
of  
Champaign County Zoning Board of Appeals**

---

Final Determination: ***{GRANTED/ GRANTED WITH SPECIAL CONDITIONS/ DENIED}***

Date: ***{July 25, 2019}***

Petitioners: **Steven Hillard**

Request: **Authorize a Special Use Permit for the use of an existing artificial lake of 1 or more acres in area in the CR Conservation-Recreation Zoning District**

---

**Table of Contents**

**General Application Information ..... 2**  
**Specific Ordinance Requirements ..... 3 - 6**  
**Special Use Evidence..... 6 - 12**  
**Documents of Record..... 13**  
**Case 146-S-24 Finding of Fact..... 14 - 15**  
**Case 146-S-24 Final Determination ..... 16**

***PRELIMINARY DRAFT***

**SUMMARY OF EVIDENCE**

From the documents of record and the testimony and exhibits received at the public hearing conducted on **July 25, 2024**, the Zoning Board of Appeals of Champaign County finds that:

1. Petitioner Steven Hillard owns the subject property.
2. The subject property is a 20.44-acre tract in the Northwest quarter of Section 26, Township 21 North, Range 7 East of the Third Principal Meridian, in Newcomb Township, also known as tract 4B on a Plat of Survey recorded as Document No. 2022R10868 recorded with the Champaign County Recorder of Deeds, with an address of 2567 CR 450E, Mahomet.
3. Regarding municipal extraterritorial jurisdiction and township planning jurisdiction:
  - A. The subject property is not located within the one and one-half mile extraterritorial jurisdiction of a municipality with zoning.
  - B. The subject property is located within Newcomb Township, which has a Plan Commission. Townships with Plan Commissions do not have protest rights on Special Use Permits; however, they do receive notice of such cases and they are invited to comment.

***GENERALLY REGARDING LAND USE AND ZONING IN THE IMMEDIATE VICINITY***

4. Land use and zoning on the subject property and in the vicinity adjacent to the subject property are as follows:
  - A. The subject property is zoned CR Conservation-Recreation and is a residential lot that contained a single-family residence that was recently demolished, residential accessory buildings, two ponds and a wooded area. A new single-family residence is under construction.
  - B. Land to the north of the subject property is zoned CR Conservation Recreation and is residential in use.
  - C. Land to the east of the subject property is zoned AG-1 Agriculture and is partially residential in use and partially in agricultural production.
  - D. Land to the south of the subject property is zoned CR Conservation Recreation and is residential in use.
  - E. Land to the west of the subject property is zoned CR Conservation Recreation and is along the Sangamon River and is residential in use.

***GENERALLY REGARDING THE PROPOSED SPECIAL USE***

5. Regarding the site plan for the proposed Special Use:
  - A. The Site Plan received June 25, 2024, indicates the following existing and proposed features:
    - (1) An existing, approximately 2.6-acre pond with an overflow outlet located on the north side of the pond; and



- (2) An existing .5-acre pond.
  - (3) A proposed single-family residence to the east of the larger pond on the site of the previously demolished residence and a new driveway entrance from County Road 450E. The proposed residence and driveway were approved by Zoning Use Permit #120-24-01 and are not a part of the Special Use Permit.
- B. There is one previous Zoning Use Permit on the subject property:
- (1) ZUPA #291-96-01 was approved on November 8, 1996, for construction of a single-family residence.
- C. A smaller pond was constructed on the property at some time and was later expanded to its current dimensions between 2002 and 2005 by a previous owner without a Special Use Permit. A second smaller pond was constructed around the same time.
- C. There are no previous zoning cases on the subject property.

**GENERALLY REGARDING SPECIFIC ORDINANCE REQUIREMENTS**

6. Regarding authorization for an artificial lake of 1 acre or more in the CR Conservation-Recreation Zoning DISTRICT in the *Zoning Ordinance*:
- A. The following definitions from the *Zoning Ordinance* are especially relevant to the requested Special Use Permit (capitalized words are defined in the Ordinance):
- (1) “ACCESS” is the way MOTOR VEHICLES move between a STREET or ALLEY and the principal USE or STRUCTURE on a LOT abutting such STREET or ALLEY.
  - (2) “BEST PRIME FARMLAND” is Prime Farmland Soils identified in the Champaign County Land Evaluation and Site Assessment (LESA) System that under optimum management have 91% to 100% of the highest soil productivities in Champaign County, on average, as reported in the *Bulletin 811 Optimum Crop Productivity Ratings for Illinois Soils*. Best Prime Farmland consists of the following:
    - a. Soils identified as Agriculture Value Groups 1, 2, 3 and/or 4 in the Champaign County LESA system;
    - b. Soils that, in combination on a subject site, have an average LE of 91 or higher, as determined by the Champaign County LESA system;
    - c. Any development site that includes a significant amount (10% or more of the area proposed to be developed) of Agriculture Value Groups 1, 2, 3 and/or 4 soils as determined by the Champaign County LESA system.
  - (3) “LOT” is a designated parcel, tract or area of land established by PLAT, SUBDIVISION or as otherwise permitted by law, to be used, developed or built upon as a unit.
  - (4) “SPECIAL CONDITION” is a condition for the establishment of a SPECIAL USE.
  - (5) “SPECIAL USE” is a USE which may be permitted in a DISTRICT pursuant to, and in compliance with, procedures specified herein.

**PRELIMINARY DRAFT**

- (6) “STREET” is a thoroughfare dedicated to the public within a RIGHT-OF-WAY which affords the principal means of ACCESS to abutting PROPERTY. A STREET may be designated as an avenue, a boulevard, a drive, a highway, a lane, a parkway, a place, a road, a thoroughfare, or by other appropriate names. STREETS are identified on the Official Zoning Map according to type of USE, and generally as follows:
- (a) MAJOR STREET: Federal or State highways.
  - (b) COLLECTOR STREET: COUNTY highways and urban arterial STREETS.
  - (c) MINOR STREET: Township roads and other local roads.
- (7) “SUITED OVERALL” is a discretionary review performance standard to describe the site on which a development is proposed. A site may be found to be SUITED OVERALL if the site meets these criteria:
- a. The site features or site location will not detract from the proposed use;
  - b. The site will not create a risk to health, safety or property of the occupants, the neighbors or the general public;
  - c. The site is not clearly inadequate in one respect even if it is acceptable in other respects;
  - d. Necessary infrastructure is in place or provided by the proposed development; and
  - e. Available public services are adequate to support the proposed development effectively and safely.
- (8) “USE” is the specific purpose for which land, a STRUCTURE or PREMISES, is designed, arranged, intended, or for which it is or may be occupied or maintained. The term “permitted USE” or its equivalent shall not be deemed to include any NONCONFORMING USE.
- (9) WELL SUITED OVERALL: A discretionary review performance standard to describe the site on which a development is proposed. A site may be found to be WELL SUITED OVERALL if the site meets these criteria:
- a. The site is one on which the proposed development can be safely and soundly accommodated using simple engineering and common, easily maintained construction methods with no unacceptable negative effects on neighbors or the general public; and
  - b. The site is reasonably well-suited in all respects and has no major defects.
- B. Regarding authorization for “artificial lake” in the Zoning Ordinance:
- (1) “Artificial lake of one or more acres” has always been authorized only as a Special Use Permit in the Zoning Ordinance.
  - (2) Section 6.1.3 of the *Zoning Ordinance* establishes Standard Conditions that are applicable to Special Use Permits. The only standard condition for an artificial lake of one or more acres is a minimum lot area of one acre.
- C. Subsection 6.1 contains standard conditions that apply to all SPECIAL USES, standard conditions that may apply to all SPECIAL USES, and standard conditions for specific types of SPECIAL USES. Relevant requirements from Subsection 6.1 are as follows:



- (1) Paragraph 6.1.2 A. indicates that all Special Use Permits with exterior lighting shall be required to minimize glare on adjacent properties and roadways by the following means:
- a. All exterior light fixtures shall be full-cutoff type lighting fixtures and shall be located and installed so as to minimize glare and light trespass. Full cutoff means that the lighting fixture emits no light above the horizontal plane.
  - b. No lamp shall be greater than 250 watts and the Board may require smaller lamps when necessary.
  - c. Locations and numbers of fixtures shall be indicated on the site plan (including floor plans and building elevations) approved by the Board.
  - d. The Board may also require conditions regarding the hours of operation and other conditions for outdoor recreational uses and other large outdoor lighting installations.
  - e. The Zoning Administrator shall not approve a Zoning Use Permit without the manufacturer's documentation of the full-cutoff feature for all exterior light fixtures.
- D. Section 9.1.11 requires that a Special Use Permit shall not be granted by the Zoning Board of Appeals unless the public hearing record and written application demonstrate the following:
- (1) That the Special Use is necessary for the public convenience at that location;
  - (2) That the Special Use is so designed, located, and proposed as to be operated so that it will not be injurious to the DISTRICT in which it shall be located or otherwise detrimental to the public welfare except that in the CR, AG-1, and AG-2 DISTRICTS the following additional criteria shall apply:
    - a. The property is either BEST PRIME FARMLAND and the property with proposed improvements in WELL SUITED OVERALL or the property is not BEST PRIME FARMLAND and the property with proposed improvements is SUITED OVERALL.
    - b. The existing public services are available to support the proposed SPECIAL USE effectively and safely without undue public expense.
    - c. The existing public infrastructure together with proposed improvements is adequate to support the proposed development effectively and safely without undue public expense.
  - (3) That the Special Use conforms to the applicable regulations and standards of and preserves the essential character of the DISTRICT in which it shall be located, except where such regulations and standards are modified by Section 6.
  - (4) That the Special Use is in harmony with the general purpose and intent of this ordinance.

**PRELIMINARY DRAFT**

(5) That in the case of an existing NONCONFORMING USE, it will make such USE more compatible with its surroundings.

E. Paragraph 9.1.11.D.2. states that in granting any SPECIAL USE permit, the BOARD may prescribe SPECIAL CONDITIONS as to appropriate conditions and safeguards in conformity with the Ordinance. Violation of such SPECIAL CONDITIONS when made a party of the terms under which the SPECIAL USE permit is granted, shall be deemed a violation of this Ordinance and punishable under this Ordinance.

**GENERALLY REGARDING WHETHER THE SPECIAL USE IS NECESSARY FOR THE PUBLIC CONVENIENCE AT THIS LOCATION**

7. Generally regarding the *Zoning Ordinance* requirement that the proposed Special Use is necessary for the public convenience at this location:
- A. The Petitioner has testified on the application, **“The home is to replace the older demolished home. The new driveway will come from the east connecting to CR 450E which will provide a more private drive for Lot 2A. The older drive from the south comes off a shared driveway and will be removed.”**
  - B. The artificial lake existed on the property prior to the Petitioner purchasing the property in 2022. The Special Use Permit is only for the lake, which will be a private lake for use by the property owners and their guests.
  - C. There have been no complaints about the lake.

**GENERALLY REGARDING WHETHER THE SPECIAL USE WILL BE INJURIOUS TO THE DISTRICT OR OTHERWISE INJURIOUS TO THE PUBLIC WELFARE**

8. Generally regarding the *Zoning Ordinance* requirement that the proposed Special Use be designed, located, and operated so that it will not be injurious to the District in which it shall be located, or otherwise detrimental to the public welfare:
- A. The Petitioner has testified on the application, **“The use will remain the same and the improvements will be in the same location and approximate size. The existing drainage will remain the same and there is no work to be done on the existing private pond. Pond calculations and evaluation of existing pond show there is 10 times the volume needed.”**
  - B. Regarding surface drainage:
    - (1) The petitioners engineer has indicated that the natural drainage path of the property is to the north and then to the northwest to the Sangamon River. The construction of the pond and the improvements on the property have not affected the natural drainage of the area. The pond has sufficient volume to contain the water from multiple 100-year storm events before overflowing to the natural drainage path.
  - C. Regarding traffic in the subject property area:
    - (1) The existing pond on the subject property and the proposed single-family residence that will replace the recently demolished residence will not create any increase in traffic to the area.



- (2) The Newcomb Township Road Commissioner has been notified of this case and no comments have been received.
- D. Regarding fire protection on the subject property, the subject property is located 4.9 road miles from the Cornbelt Fire Protection District station in Mahomet. The FPD Chief was notified of this case and no comments have been received.
- E. The western part of the property is in the mapped floodplain. There are no existing or proposed improvements in the floodplain.
- F. The subject property is not considered Best Prime Farmland.
- G. Regarding outdoor lighting on the subject property: the Petitioner did not include information on their Site Plan.
- H. Regarding wastewater treatment and disposal on the subject property: the existing septic system is to the north of the proposed home site.
- I. Regarding neighborhood concerns, no comments have been received as of July 17, 2024.
- J. Other than as reviewed in this Summary of Evidence, there is no evidence to suggest that the proposed Special Use will generate either nuisance conditions such as odor, noise, vibration, glare, heat, dust, electromagnetic fields or public safety hazards such as fire, explosion, or toxic materials release, that are in excess of those lawfully permitted and customarily associated with other uses permitted in the zoning district.

***GENERALLY REGARDING WHETHER THE SPECIAL USE CONFORMS TO APPLICABLE REGULATIONS AND STANDARDS AND PRESERVES THE ESSENTIAL CHARACTER OF THE DISTRICT***

- 9. Generally regarding the *Zoning Ordinance* requirement that the proposed Special Use conform to all applicable regulations and standards and preserve the essential character of the District in which it shall be located, except where such regulations and standards are modified by Section 6 of the Ordinance:
  - A. The Petitioner has testified on the application: **“Yes.”**
  - B. Regarding compliance with the *Zoning Ordinance*:
    - (1) Section 5.2: Table of Authorized Principal Uses states that an artificial lake of 1 acre or more can be established with a Special Use Permit in the CR Conservation-Recreation Zoning District.
    - (2) Because the artificial lake is existing it can be added to the Zoning Use Permit for the single-family residence that is under construction and no separate Zoning Use Permit is required.
    - (3) Regarding Best Prime Farmland:
      - a. The subject property is not considered Best Prime Farmland.
  - C. Regarding compliance with the *Storm Water Management and Erosion Control Ordinance*:

**PRELIMINARY DRAFT**

- (1) The existing artificial lake has been in place for nearly 20 years, and no changes are proposed.
  - (2) The petitioners engineer has stated that the grass weir overflow on the north side of the pond is sufficient to prevent erosion or sedimentation should the pond overflow.
  - (3) The proposed new single-family residence and driveway are required to comply with Illinois Environmental Protection Agency (IEPA) National Pollutant Discharge Elimination System (NPDES) "ILR10" General Construction Storm Water Permit regulations.
- D. Regarding the Special Flood Hazard Areas Ordinance, the western part of the property is in the mapped floodplain. There are no existing or proposed improvements in the floodplain.
- E. Regarding the Subdivision Regulations, the subject property is located in Champaign County's subdivision jurisdiction and the subject property is in compliance.
- F. Regarding the requirement that the Special Use preserve the essential character of the CR Conservation-Recreation Zoning District:
- (1) Artificial lakes of 1 acre or more are allowed with a Special Use Permit in the CR Conservation-Recreation Zoning District.

**GENERALLY REGARDING WHETHER THE SPECIAL USE IS IN HARMONY WITH THE GENERAL PURPOSE AND INTENT OF THE ORDINANCE**

10. Regarding the *Zoning Ordinance* requirement that the proposed Special Use be in harmony with the general intent and purpose of the Ordinance:
- A. Section 5.2: Table of Authorized Principal Uses states that an artificial lake of 1 acre or more can be established with a Special Use Permit in the CR Conservation-Recreation Zoning District.
  - B. Regarding whether the proposed Special Use Permit is in harmony with the general intent of the Zoning Ordinance:
    - (1) Subsection 5.1.3 of the Ordinance states the general intent of the CR Conservation-Recreation DISTRICT and states as follows (capitalized words are defined in the Ordinance):
 

The CR Conservation-Recreation DISTRICT is intended to protect the public health by restricting development in areas subject to frequent or periodic floods and to conserve the natural and scenic areas generally along the major stream networks of the COUNTY.
    - (2) The types of uses authorized in the CR District are in fact the types of uses that have been determined to be acceptable in the CR District. Uses authorized by Special Use Permit are acceptable uses in the district provided that they are determined by the ZBA to meet the criteria for Special Use Permits established in paragraph 9.1.11 B. of the Ordinance.



- C. Regarding whether the proposed Special Use Permit is in harmony with the general purpose of the Zoning Ordinance:
- (1) Paragraph 2.0 (a) of the Ordinance states that one purpose of the zoning regulations and standards that have been adopted and established is to secure adequate light, pure air, and safety from fire and other dangers.  
  
This purpose is directly related to the limits on building coverage and the minimum yard requirements in the Ordinance and the proposed site plan is in compliance with those requirements.
  - (2) Paragraph 2.0 (b) of the Ordinance states that one purpose of the zoning regulations and standards that have been adopted and established is to conserve the value of land, BUILDINGS, and STRUCTURES throughout the COUNTY.
    - a. It is not clear whether or not the proposed special use will have any impact on the value of nearby properties without a formal real estate appraisal, which has not been requested nor provided, and so any discussion of values is necessarily general.
    - b. In regards to the value of the subject property, it also is not clear if the requested Special Use Permit would have any effect. Regarding the effect on the value of the subject property, the subject property has been used as a single-family residence since 1996. The existing artificial lake has been on the property for almost 20 years and its removal would have an effect on the value of the property.
  - (3) Paragraph 2.0 (c) of the Ordinance states that one purpose of the zoning regulations and standards that have been adopted and established is to lessen and avoid congestion in the public streets.  
The proposed Special Use is unlikely to increase traffic.
  - (4) Paragraph 2.0 (d) of the Ordinance states that one purpose of the zoning regulations and standards that have been adopted and established is to lessen and avoid hazards to persons and damage to property resulting from the accumulation of runoff of storm or flood waters.
    - a. The subject property is partially located in a mapped floodplain, however no changes have been proposed in the floodplain.
    - b. The proposed home and new driveway entrance will have a small effect on the water level of the pond, but the capacity of the pond should prevent any additional water being discharged onto neighboring properties.
    - c. Regarding compliance with the *Storm Water Management and Erosion Control Ordinance*, there will be no changes to the artificial lake.
  - (5) Paragraph 2.0 (e) of the Ordinance states that one purpose of the zoning regulations and standards that have been adopted and established is to promote the public health, safety, comfort, morals, and general welfare.
    - a. In regards to public safety, this purpose is similar to the purpose established in paragraph 2.0 (a) and is in harmony to the same degree.

**PRELIMINARY DRAFT**

- b. In regards to public comfort and general welfare, this purpose is similar to the purpose of conserving property values established in paragraph 2.0 (b) and is in harmony to the same degree.
- (6) Paragraph 2.0 (f) states that one purpose of the Ordinance is regulating and limiting the height and bulk of BUILDINGS and STRUCTURES hereafter to be erected; and paragraph 2.0 (g) states that one purpose is establishing, regulating, and limiting the BUILDING or SETBACK lines on or along any STREET, trafficway, drive or parkway; and paragraph 2.0 (h) states that one purpose is regulating and limiting the intensity of the USE of LOT AREAS, and regulating and determining the area of OPEN SPACES within and surrounding BUILDINGS and STRUCTURES.

These three purposes are directly related to the limits on building height and building coverage and the minimum setback and yard requirements in the Ordinance and the existing artificial lake is in compliance with those limits.

- (7) Paragraph 2.0 (i) of the Ordinance states that one purpose of the Ordinance is classifying, regulating, and restricting the location of trades and industries and the location of BUILDINGS, STRUCTURES, and land designed for specified industrial, residential, and other land USES; and paragraph 2.0 (j.) states that one purpose is dividing the entire COUNTY into DISTRICTS of such number, shape, area, and such different classes according to the USE of land, BUILDINGS, and STRUCTURES, intensity of the USE of LOT AREA, area of OPEN SPACES, and other classification as may be deemed best suited to carry out the purpose of the ordinance; and paragraph 2.0 (k) states that one purpose is fixing regulations and standards to which BUILDINGS, STRUCTURES, or USES therein shall conform; and paragraph 2.0 (l) states that one purpose is prohibiting USES, BUILDINGS, OR STRUCTURES incompatible with the character of such DISTRICT.

Harmony with these four purposes requires that the special conditions of approval sufficiently mitigate or minimize any incompatibilities between the proposed Special Use Permit and adjacent uses, and that the special conditions adequately mitigate any problematic conditions.

- (8) Paragraph 2.0 (m) of the Ordinance states that one purpose of the zoning regulations and standards that have been adopted and established is to prevent additions to and alteration or remodeling of existing buildings, structures, or uses in such a way as to avoid the restrictions and limitations lawfully imposed under this ordinance. This purpose is directly related to maintaining compliance with the Zoning Ordinance requirements for the District and the specific types of uses and the proposed Special Use will have to be conducted in compliance with those requirements.
- (9) Paragraph 2.0 (n) of the Ordinance states that one purpose of the zoning regulations and standards that have been adopted and established is to protect the most productive agricultural lands from haphazard and unplanned intrusions of urban uses.
- a. The proposed Special Use does not meet the definition of either “urban development” or “urban land use” as defined in the Appendix to Volume 2 of the Champaign County Land Resource Management Plan.



- b. The subject property is not in agricultural production. The property has been used as single-family residence since 1996.
- (10) Paragraph 2.0 (o) of the Ordinance states that one purpose of the zoning regulations and standards that have been adopted and established is to protect natural features such as forested areas and watercourses.

The western part of the property is wooded and abuts the Sangamon River. The wooded area is within the floodplain and there is no proposed construction in this area.

- (11) Paragraph 2.0 (p) of the Ordinance states that one purpose of the zoning regulations and standards that have been adopted and established is to encourage the compact development of urban areas to minimize the cost of development of public utilities and public transportation facilities.
- a. The proposed Special Use does not meet the definition of either “urban development” or “urban land use” as defined in the Appendix to Volume 2 of the Champaign County Land Resource Management Plan.
- b. No public utilities or transportation facilities improvements are needed.
- (12) Paragraph 2.0 (q) of the Ordinance states that one purpose of the zoning regulations and standards that have been adopted and established is to encourage the preservation of agricultural belts surrounding urban areas, to retain the agricultural nature of the County, and the individual character of existing communities.

The subject property is not in agricultural production.

- (13) Paragraph 2.0 (r) of the Ordinance states that one purpose of the zoning regulations and standards that have been adopted and established is to provide for the safe and efficient development of renewable energy sources in those parts of the COUNTY that are most suited to their development.

The proposed Special Use will not hinder the development of renewable energy sources.

***GENERALLY REGARDING WHETHER THE SPECIAL USE IS AN EXISTING NONCONFORMING USE***

11. Regarding the *Zoning Ordinance* requirement that in the case of an existing NONCONFORMING USE the granting of the Special Use Permit will make the use more compatible with its surroundings:
- A. The Petitioner has testified on the application: “Yes”
- B. The existing artificial lake on the property is not a nonconforming use.

***GENERALLY REGARDING PROPOSED SPECIAL CONDITIONS OF APPROVAL***

***PRELIMINARY DRAFT***

12. Regarding proposed special conditions of approval:

- A. **The artificial lake shall be added to Zoning Use Permit #120-24-01 for the single-family residence.**

The above special condition is required to ensure the following:

**The establishment of the proposed use shall be properly documented as required by the Zoning Ordinance.**



**DOCUMENTS OF RECORD**

1. Application for Special Use Permit received June 25, 2024, with attachments:
  - A Site Plan and Driveway Plan received June 25, 2024
2. Email from Petitioners Engineer received June 10, 2024
3. Pond Routing and Pond Calculation information from Petitioners Engineer received June 10, 2024
4. Plat of Survey Document #2022R10868
5. Warranty Deed Document #2022R12208
3. Preliminary Memorandum dated July 17, 2024, with attachments:
  - A Case Maps (Location, Land Use, Zoning)
  - B Site Plan and Driveway Plan received June 25, 2024
  - C Email from Petitioners Engineer received June 10, 2024
  - D Pond Routing and Pond Calculation information from Petitioners Engineer received June 10, 2024
  - E Annotated Aerial Photos 1988, 2002, 2005, 2023, 3013 Floodplain
  - F Site Images taken July 16, 2024
  - G Draft Summary of Evidence, Finding of Fact, and Final Determination for Case 143-V-24 dated July 25, 2024

**PRELIMINARY DRAFT****FINDINGS OF FACT**

From the documents of record and the testimony and exhibits received at the public hearing for zoning case **146-S-24** held on **July 25, 2024**, the Zoning Board of Appeals of Champaign County finds that:

1. The requested Special Use Permit *{IS / IS NOT}* necessary for the public convenience at this location because:
  - a. *The lake has existed sine before 2005 and no complaints have been received.*
2. The requested Special Use Permit *{SUBJECT TO THE SPECIAL CONDITIONS IMPOSED HEREIN}* is so designed, located, and proposed to be operated so that it *{WILL NOT / WILL}* be injurious to the district in which it shall be located or otherwise detrimental to the public health, safety, and welfare because:
  - a. The street has *{ADEQUATE / INADEQUATE}* traffic capacity and the entrance location has *{ADEQUATE / INADEQUATE}* visibility.
  - b. Emergency services availability is *{ADEQUATE / INADEQUATE}* because: *the lake will not increase demand for emergency services.*
  - c. The Special Use *{WILL / WILL NOT}* be compatible with adjacent uses because: *the lake has existed since 2005 and new homes have been built in the surrounding area and no complaints have been received.*
  - d. Surface and subsurface drainage will be *{ADEQUATE / INADEQUATE}* because: *the petitioners engineer has stated that the lake has not affected the natural drainage and the lake has sufficient volume to contain the water from multiple 100-year storm events.*
  - e. Public safety will be *{ADEQUATE / INADEQUATE}* because: *relevant jurisdictions have been notified of this case, and no comment have been received.*
  - f. The provisions for parking will be *{ADEQUATE / INADEQUATE}* because: *the pond will not increase the demand for parking and no new parking has been proposed.*

*(Note the Board may include other relevant considerations as necessary or desirable in each case.)*

\*The Board may include additional justification if desired, but it is not required.

- 3a. The requested Special Use Permit *{SUBJECT TO THE SPECIAL CONDITIONS IMPOSED HEREIN}* *{DOES / DOES NOT}* conform to the applicable regulations and standards of the DISTRICT in which it is located.
- 3b. The requested Special Use Permit *{SUBJECT TO THE SPECIAL CONDITIONS IMPOSED HEREIN}* *{DOES / DOES NOT}* preserve the essential character of the DISTRICT in which it is located because:
  - a. The Special Use will be designed to *{CONFORM / NOT CONFORM}* to all relevant County ordinances and codes.
  - b. The Special Use *{WILL / WILL NOT}* be compatible with adjacent uses.
  - c. Public safety will be *{ADEQUATE / INADEQUATE}*.



4. The requested Special Use Permit ***{SUBJECT TO THE SPECIAL CONDITIONS IMPOSED HEREIN} {IS / IS NOT}*** in harmony with the general purpose and intent of the Ordinance because:
  - a. The Special Use is authorized in the District.
  - b. The requested Special Use Permit ***{IS/ IS NOT}*** necessary for the public convenience at this location.
  - c. The requested Special Use Permit ***{SUBJECT TO THE SPECIAL CONDITIONS IMPOSED HEREIN}*** is so designed, located, and proposed to be operated so that it ***{WILL / WILL NOT}*** be injurious to the district in which it shall be located or otherwise detrimental to the public health, safety, and welfare.
  - d. The requested Special Use Permit ***{SUBJECT TO THE SPECIAL CONDITIONS IMPOSED HEREIN} {DOES / DOES NOT}*** preserve the essential character of the DISTRICT in which it is located.
  
5. The requested Special Use ***IS NOT*** an existing nonconforming use.
  
6. ***{NO SPECIAL CONDITIONS ARE HEREBY IMPOSED / THE SPECIAL CONDITIONS IMPOSED HEREIN ARE REQUIRED TO ENSURE COMPLIANCE WITH THE CRITERIA FOR SPECIAL USE PERMITS AND FOR THE PARTICULAR PURPOSES DESCRIBED BELOW:***
  - A. **The artificial lake shall be added to Zoning Use Permit #120-24-01 for the single-family residence.**

The above special condition is required to ensure the following:

**The establishment of the proposed use shall be properly documented as required by the Zoning Ordinance.**

***PRELIMINARY DRAFT***

**FINAL DETERMINATION**

The Champaign County Zoning Board of Appeals finds that, based upon the application, testimony, and other evidence received in this case, the requirements of Section 9.1.11B. for approval *{HAVE/HAVE NOT}* been met, and pursuant to the authority granted by Section 9.1.6 B. of the Champaign County Zoning Ordinance, determines that:

The Special Use requested in Case **146-S-24** is hereby *{GRANTED/ GRANTED WITH SPECIAL CONDITIONS / DENIED}* to the applicant, **Steven Hillard**, to authorize the following as a **Special Use on land in the CR Conservation-Recreation Zoning District:**

**Authorize a Special Use Permit for the use of an existing artificial lake of 1 or more acres in area in the CR Conservation-Recreation Zoning District.**

*{SUBJECT TO THE FOLLOWING SPECIAL CONDITION:}*

- A. **The artificial lake shall be added to Zoning Use Permit #120-24-01 for the single-family residence.**

The foregoing is an accurate and complete record of the Findings and Determination of the Zoning Board of Appeals of Champaign County.

SIGNED:

Ryan Elwell, Chair  
Champaign County Zoning Board of Appeals

ATTEST:

Secretary to the Zoning Board of Appeals

Date